

# BROOKLYN 93x230/300

## ISTRUZIONI DI MONTAGGIO

## INSTRUCTIONS D'ASSEMBLAGE ASSEMBLING INSTRUCTIONS

## AUFBAU ANWEISUNGEN INSTRUÇÕES DE MONTAGE

Prodotto da **IGAP** spa nello stabilimento di: 46013 Canneto S/Oglio (Mantova) Via Garibaldi, 244 • Tel. +39 0376.7172200 • Fax. +39 0376.7172290

- I** IMPORTANTE, CONSERVARE PER UN FUTURO RIFERIMENTO: LEGGERE CON ATTENZIONE.
- GB** IMPORTANT, KEEP FOR FUTURE REFERENCE: READ CAREFULLY.
- F** IMPORTANT : À LIRE ATTENTIVEMENT ET À CONSERVER POUR UNE CONSULTATION ULTÉRIEURE.
- D** WICHTIG! BITTE AUFMERKSAM DURCHLESEN UND FÜR ZUKUNFTIGE REFERENZ AUFBEWAHREN.
- E** IMPORTANTE: CONSERVE EL PRESENTE MANUAL PARA FUTURAS CONSULTAS. LEA ATENTAMENTE ESTAS INSTRUCCIONES.
- P** IMPORTANTE, GUARDAR PARA UMA REFERÊNCIA FUTURA: LER COM ATENÇÃO.

### USO ESTERNO - EXTERNAL USE - USAGE EXTERNE - ÄUSSERLICHE ANWENDUNG - USO EXTERNO - USO EXTERNO



- Tempo approssimativo assemblaggio 30 minuti, 2 persone per assemblaggio.
- *Approximate assembly time 30 minutes, 2 people per assembly.*
- Temps de montage approximatif 30 minutes, 2 personnes.
- *Ungefähre Aufbauzeit 30 Minuten, 2 Personen pro Aufbau.*
- Tiempo aproximado de ensamblaje 30 minutos, 2 personas por ensamblaje.
- *Tempo aproximado de montagem 30 minutos, 2 pessoas por montagem.*

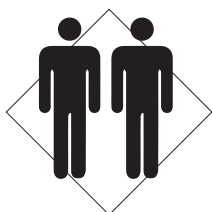

- Spazio necessario per assemblaggio, superficie piana e non abrasiva, pavimento 2m x 4m.
- *Space required for assembly, flat and non abrasive surface, 2m x 4m floor.*
- Espace requis pour le montage, surface plane et non abrasive, plancher 2m x 4m.
- *Platzbedarf für die Montage, flache und nicht abrasive Oberfläche, 2 x 4 m Boden.*
- Montar en el suelo (2x4mts) con una superficie plana y no abrasiva para evitar dañar la mesa.
- *Espaço necessário para montagem, superfície plana e não abrasiva, piso de 2m x 4m.*



- Pulire con acqua e detersivo liquido o cremoso evitando prodotti abrasivi. Risciacquare bene e asciugare.
- *Clean with water and liquid or creamy detergent avoiding abrasive products. Rinse well and dry.*
- Nettoyer avec de l'eau et un détergent liquide ou crémeux en évitant les produits abrasifs. Bien rincer et sécher.
- *Mit Wasser und flüssigem oder cremigem Reinigungsmittel reinigen und Scheuermittel vermeiden. Gut abspülen und trocknen.*
- Limpiar con agua y detergente líquido o cremoso evitando productos abrasivos. Enjuague bien y seque.
- *Limpe com água e detergente líquido ou cremoso evitando produtos abrasivos. Enxaguar bem e secar.*



- **Attenzione:** durante il montaggio bisogna indossare i guanti da lavoro.
- **Attention:** during assembly work gloves must be worn.
- **Attention:** pendant le montage, des gants de travail doivent être portés.
- **Achtung:** Während der Montagearbeiten müssen Handschuhe getragen werden.
- **Atención:** durante el montaje se deben llevar guantes de trabajo.
- **Atenção:** durante a montagem deve-se usar luvas de trabalho.

- I** ARTICOLO AD USO COLLETTIVITÀ
- GB** ARTICLE FOR COMMUNITY USE
- F** ARTICLE À USAGE DE LA COLLECTIVITÉ
- D** ARTIKEL FÜR OBJEKTBEREICH
- E** ARTÍCULO PARA COLECTIVIDADES.
- P** ARTIGO PARA USO DA COLECTIVIDADE

- I** Prodotto, testato e certificato a Norma Europea EN-581
- GB** Produced, tested and certified in compliance with European Standard EN-581
- F** Produit testé et certifié aux normes Européennes EN-581
- D** Hergestellt, getestet und zertifiziert gemäß Europäischer Norm EN-581
- E** Producto, probado y certificado según la norma europea en-581
- P** Produto, testado e certificado de acordo com a norma europeia en-581

Art. IS924101



- **Attenzione:** durante il montaggio bisogna indossare i guanti da lavoro.
- **Attention:** during assembly work gloves must be worn.
- **Attention:** pendant le montage, des gants de travail doivent être portés.
- **Achtung:** Während der Montagearbeiten müssen Handschuhe getragen werden.
- **Atención:** durante el montaje se deben llevar guantes de trabajo.
- **Atenção:** durante a montagem deve-se usar luvas de trabalho.

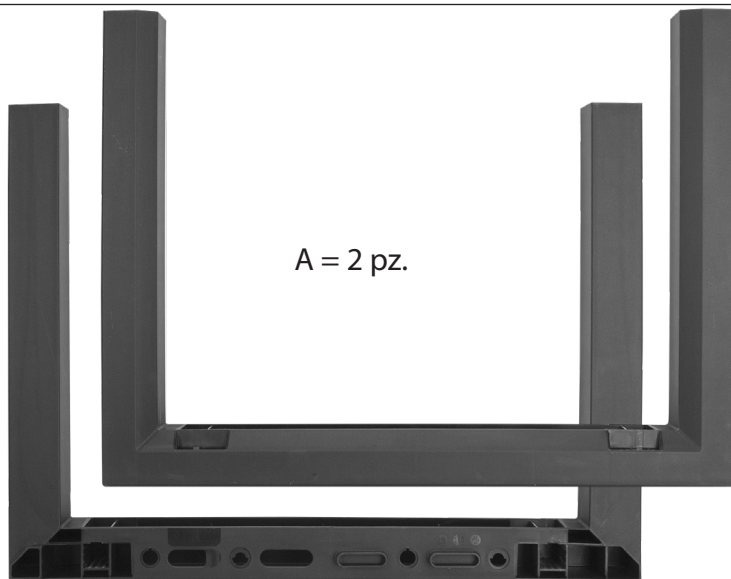

A = 2 pz.



B = 4 pz.

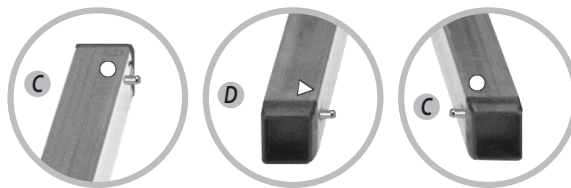

C = 2 pz.

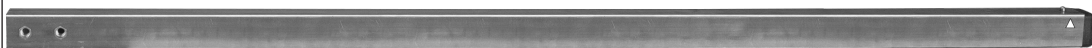

D = 2 pz.

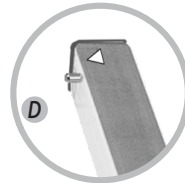

E = 2 pz.



**I** **ATTENZIONE!** Leggere le avvertenze a pagina 12.

**GB** **WARNING!** Read the warnings on page 12.

**F** **ATTENTION!** Lisez les avertissements à la page 12.

**D** **WARNUNG!** Lesen Sie die Warnungen auf Seite 12.

**E** **ADVERTENCIA!** Lea las advertencias en la página 12.

**P** **AVISO!** Lea os avisos na página 12.

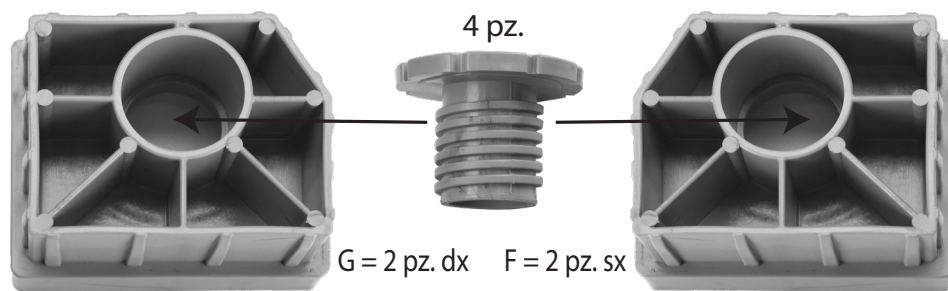

4 pz.

G = 2 pz. dx F = 2 pz. sx

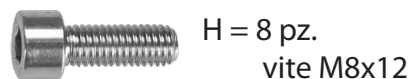

H = 8 pz.  
vite M8x12

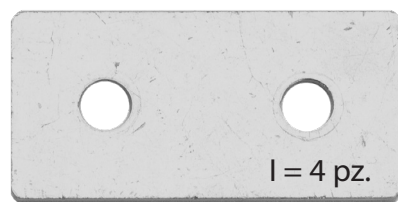

I = 4 pz.



J = 1 pz.



K = 8 pz.

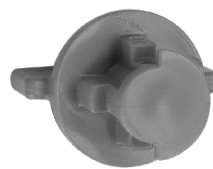

L = 14 pz.

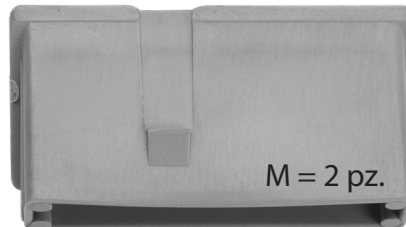

M = 2 pz.

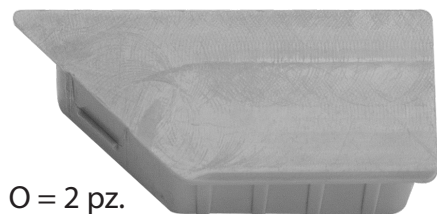

O = 2 pz.

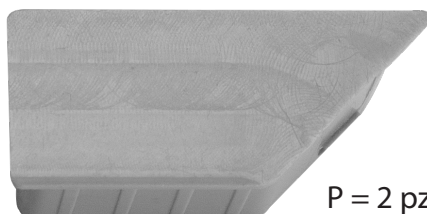

P = 2 pz.

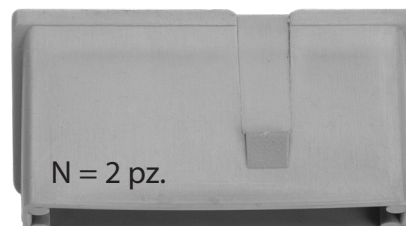

N = 2 pz.

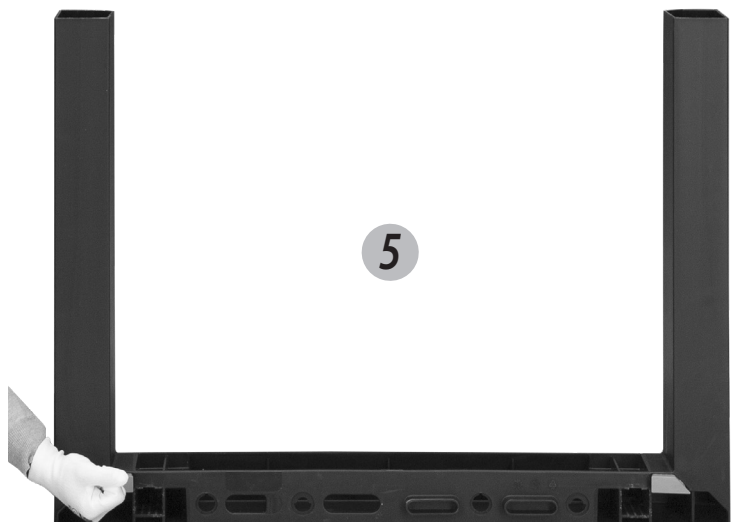
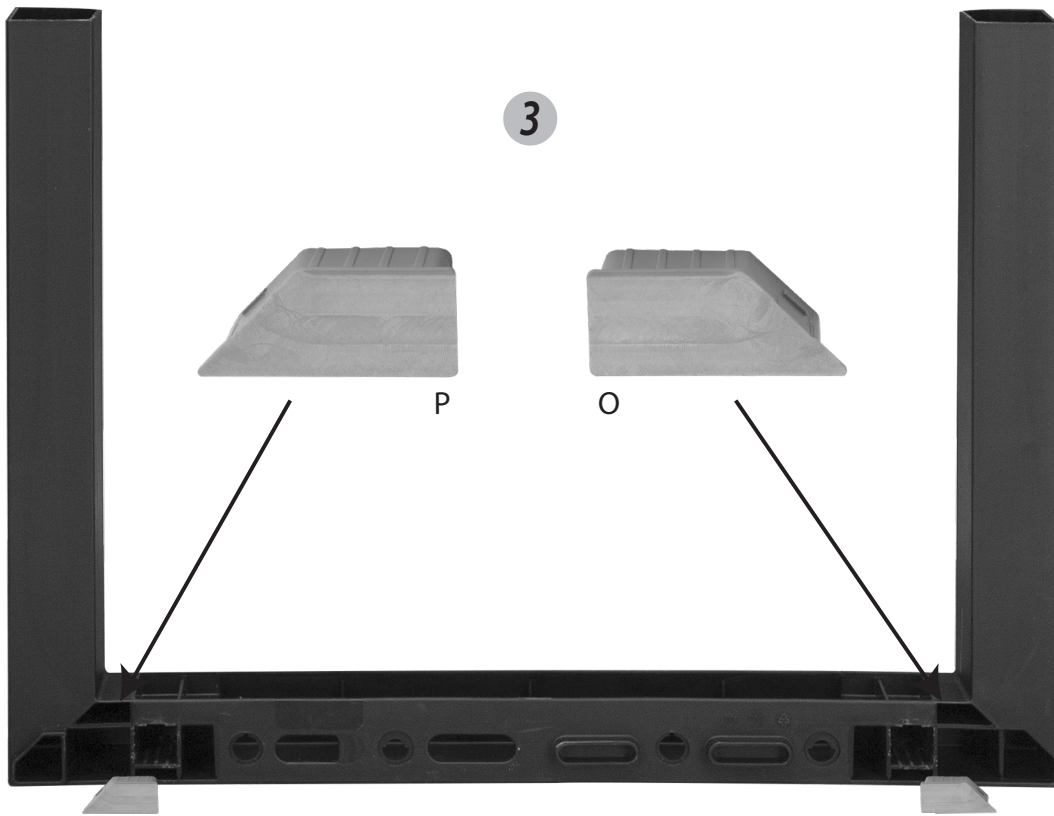
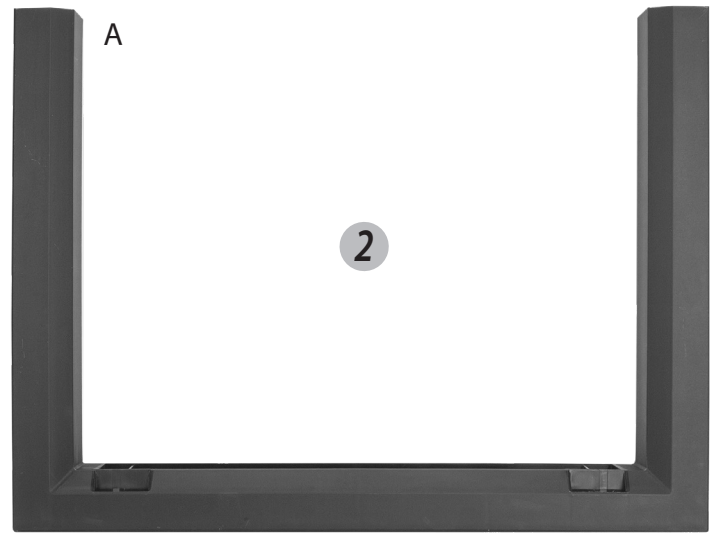
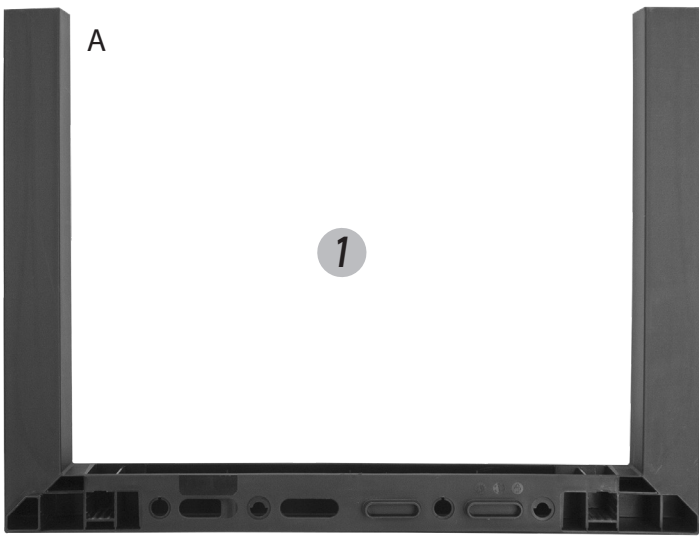

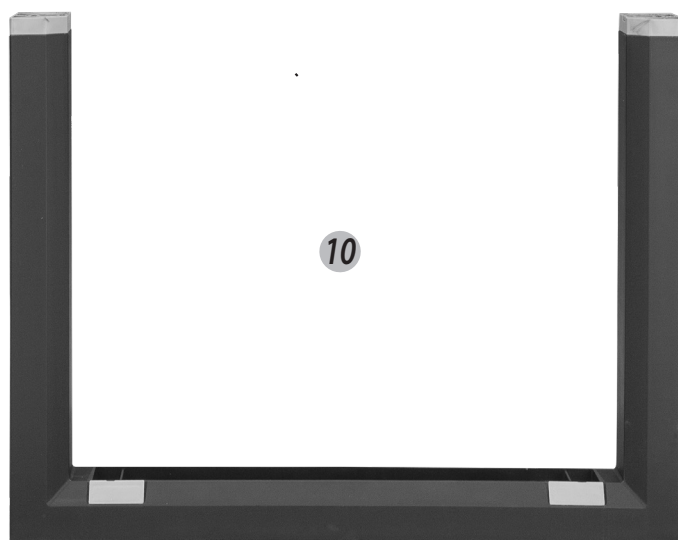
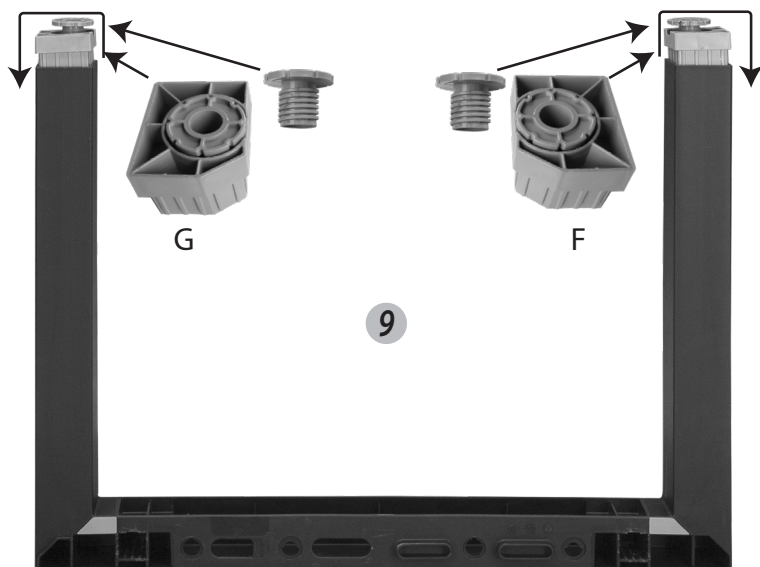
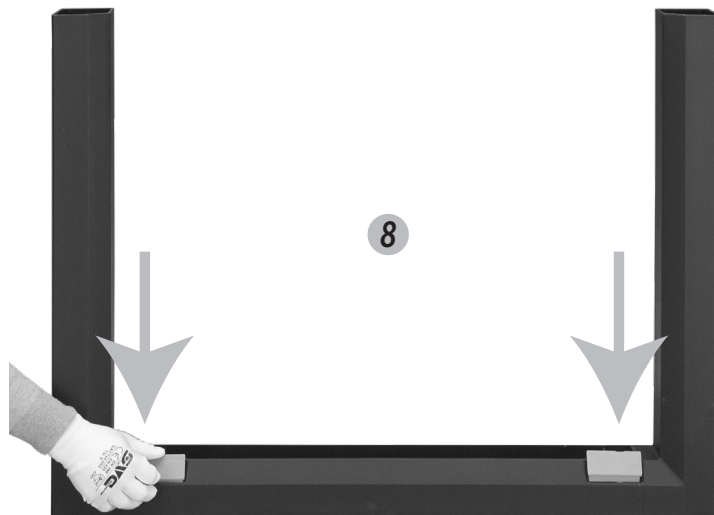
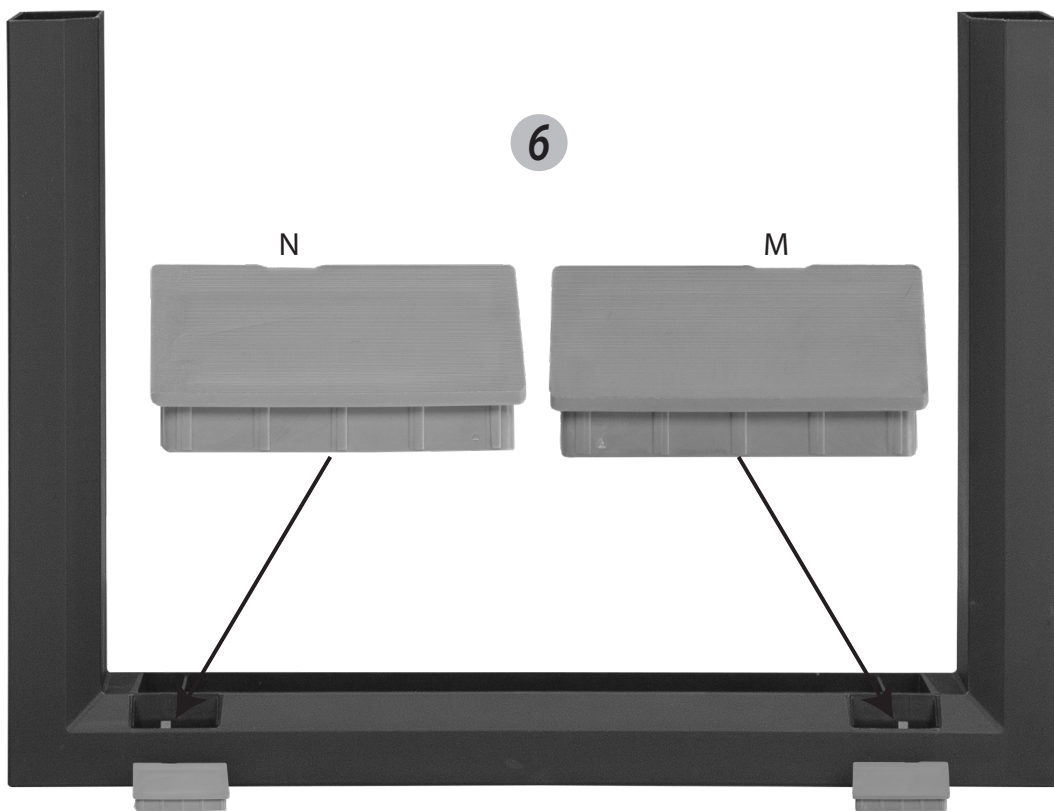

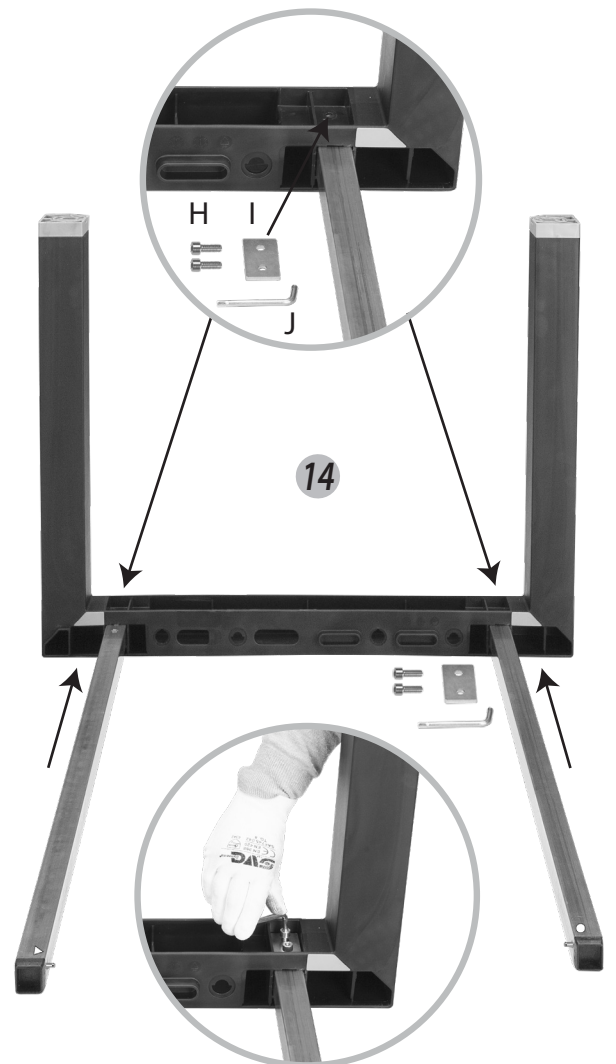
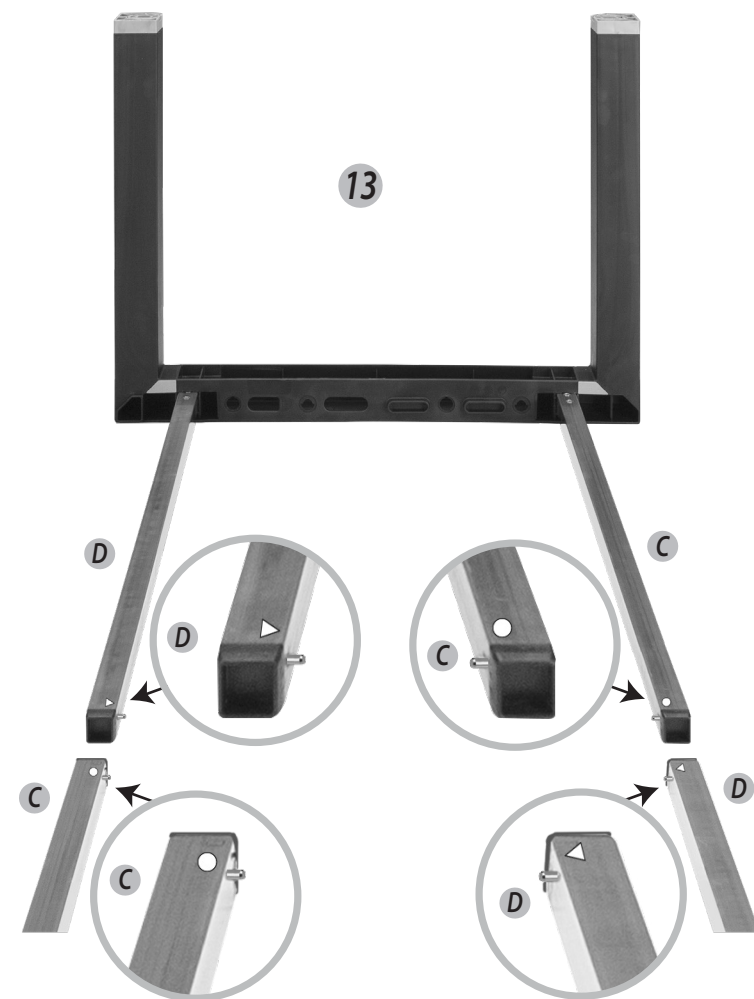
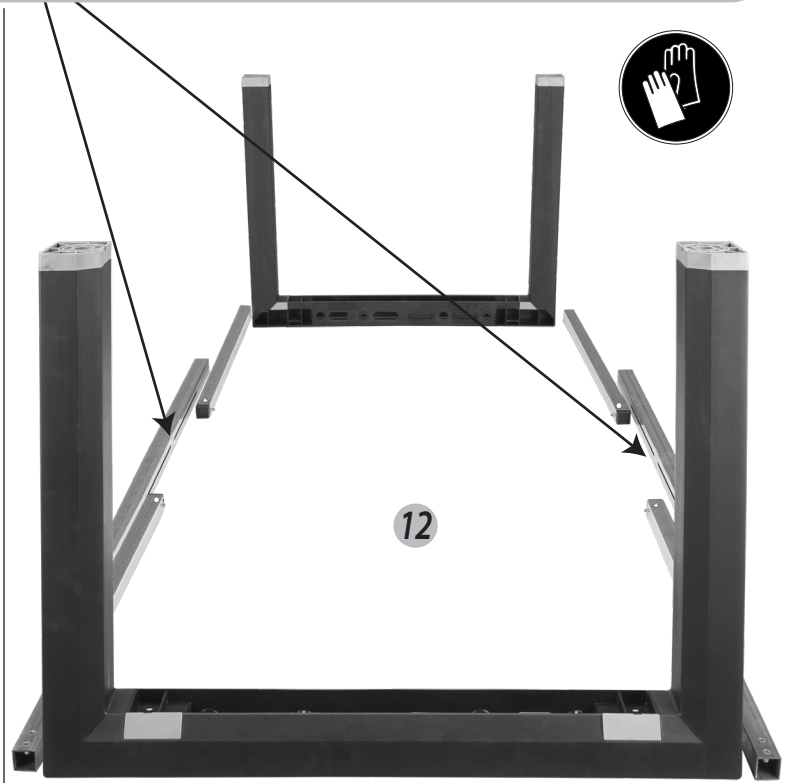



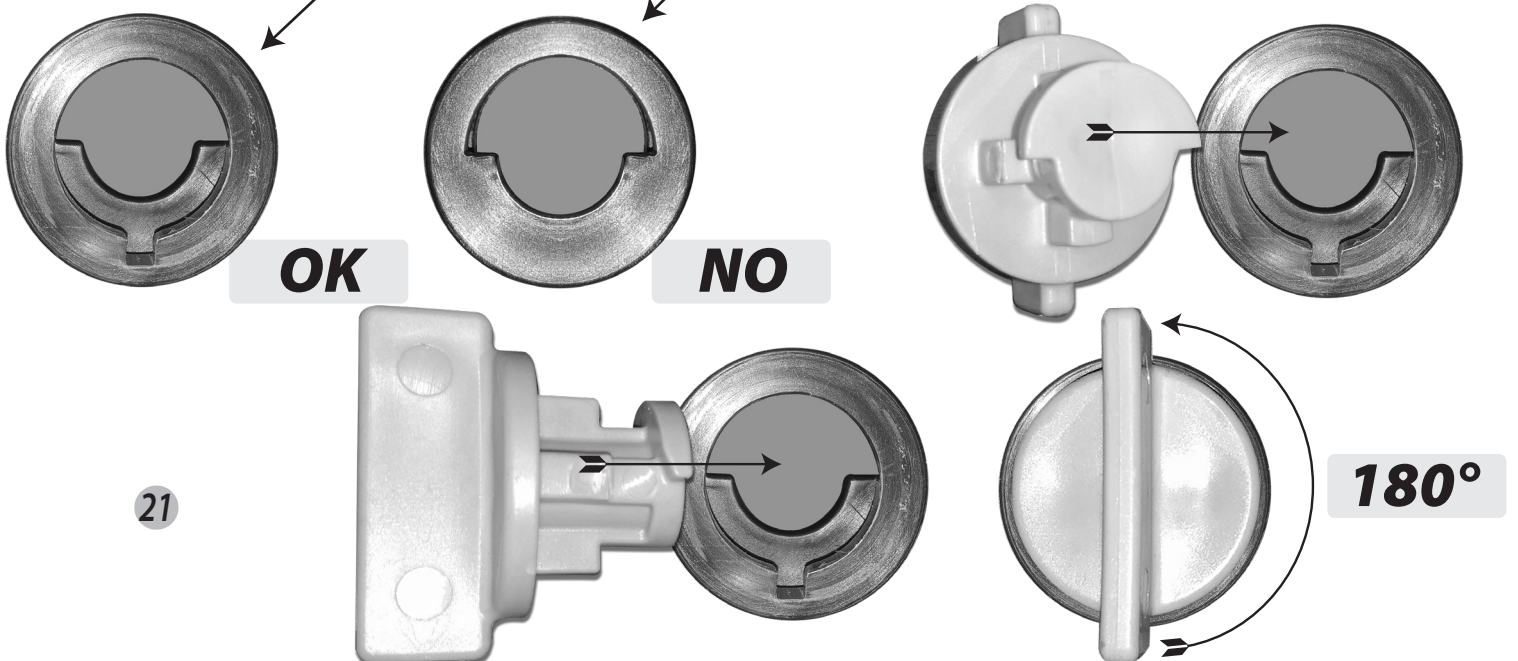
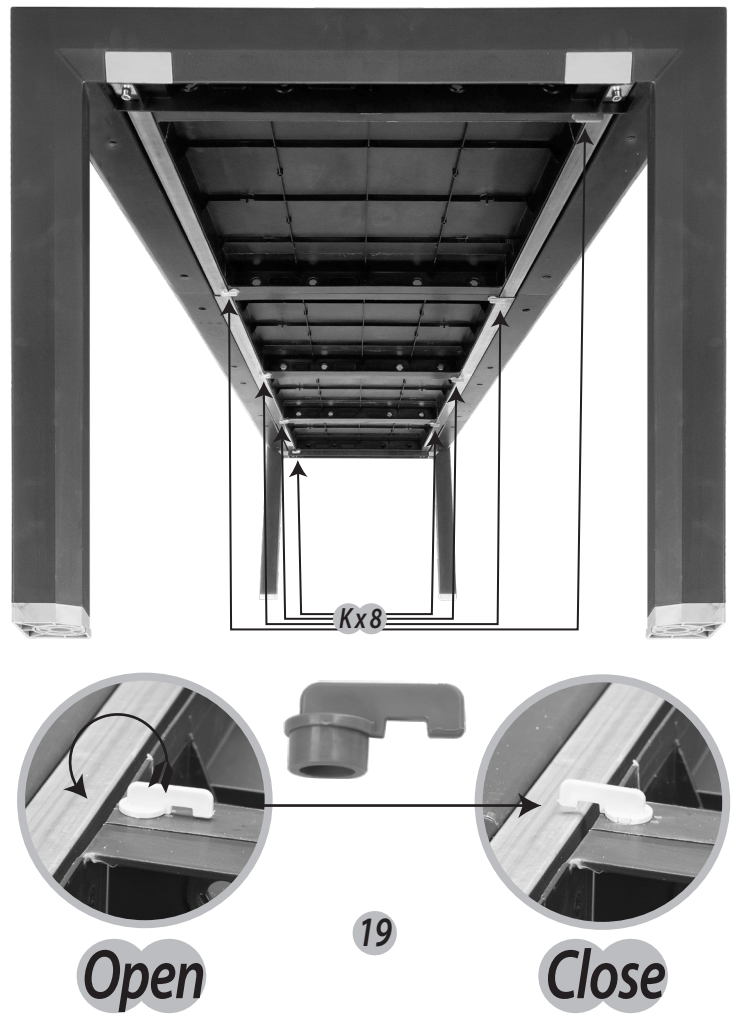
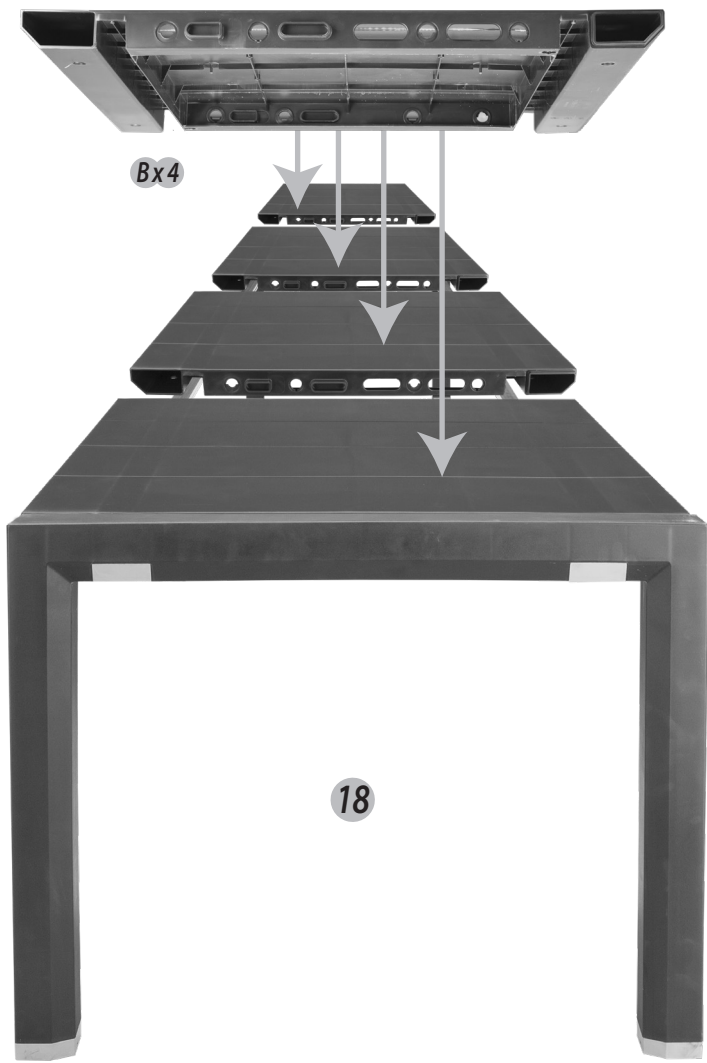

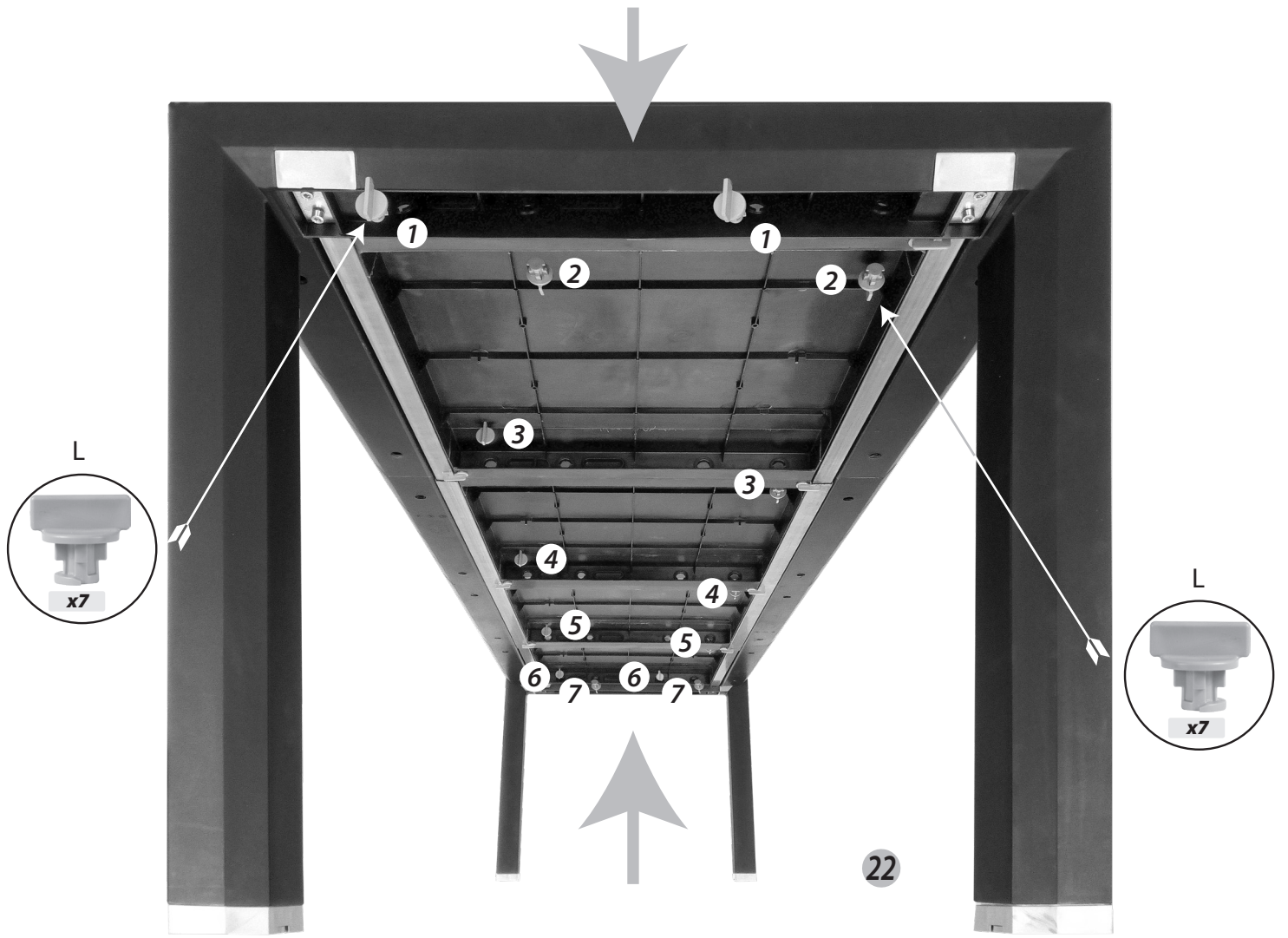



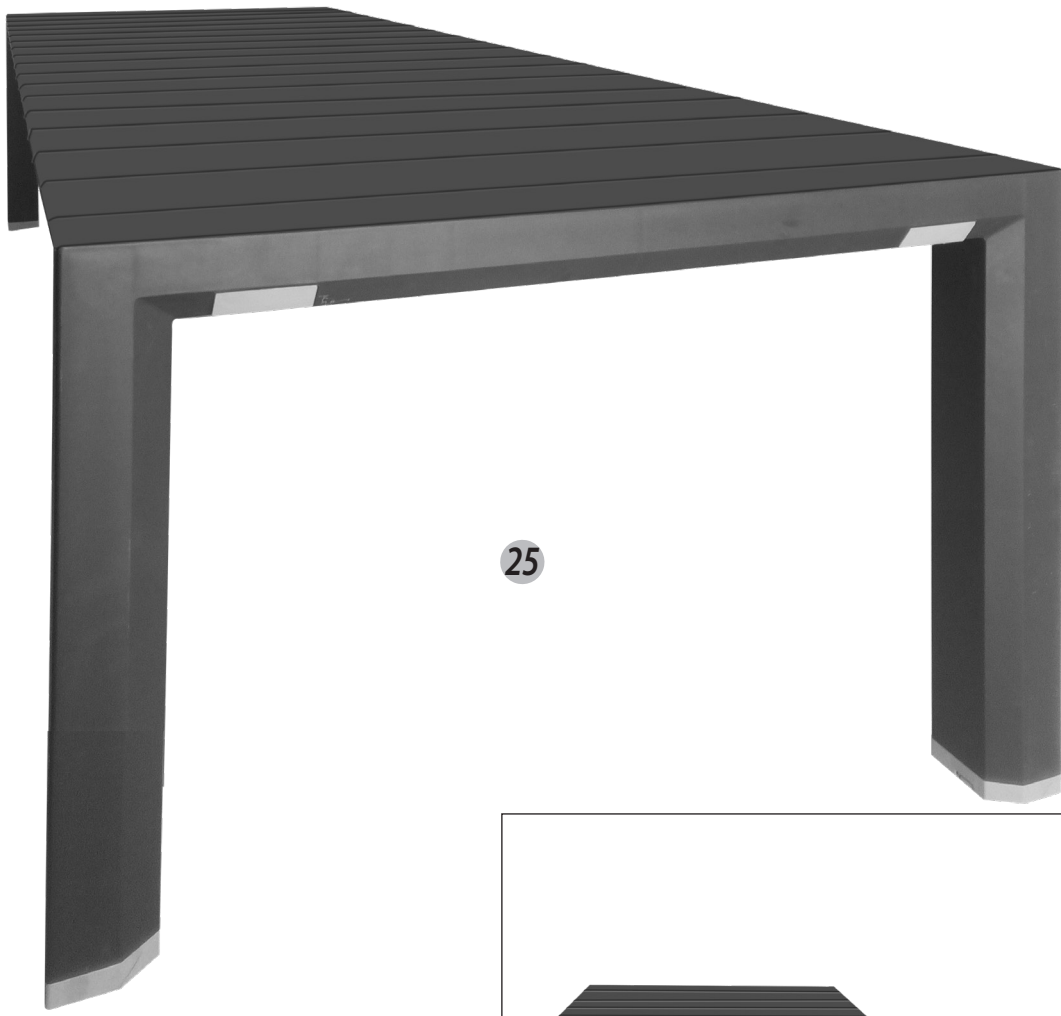

25

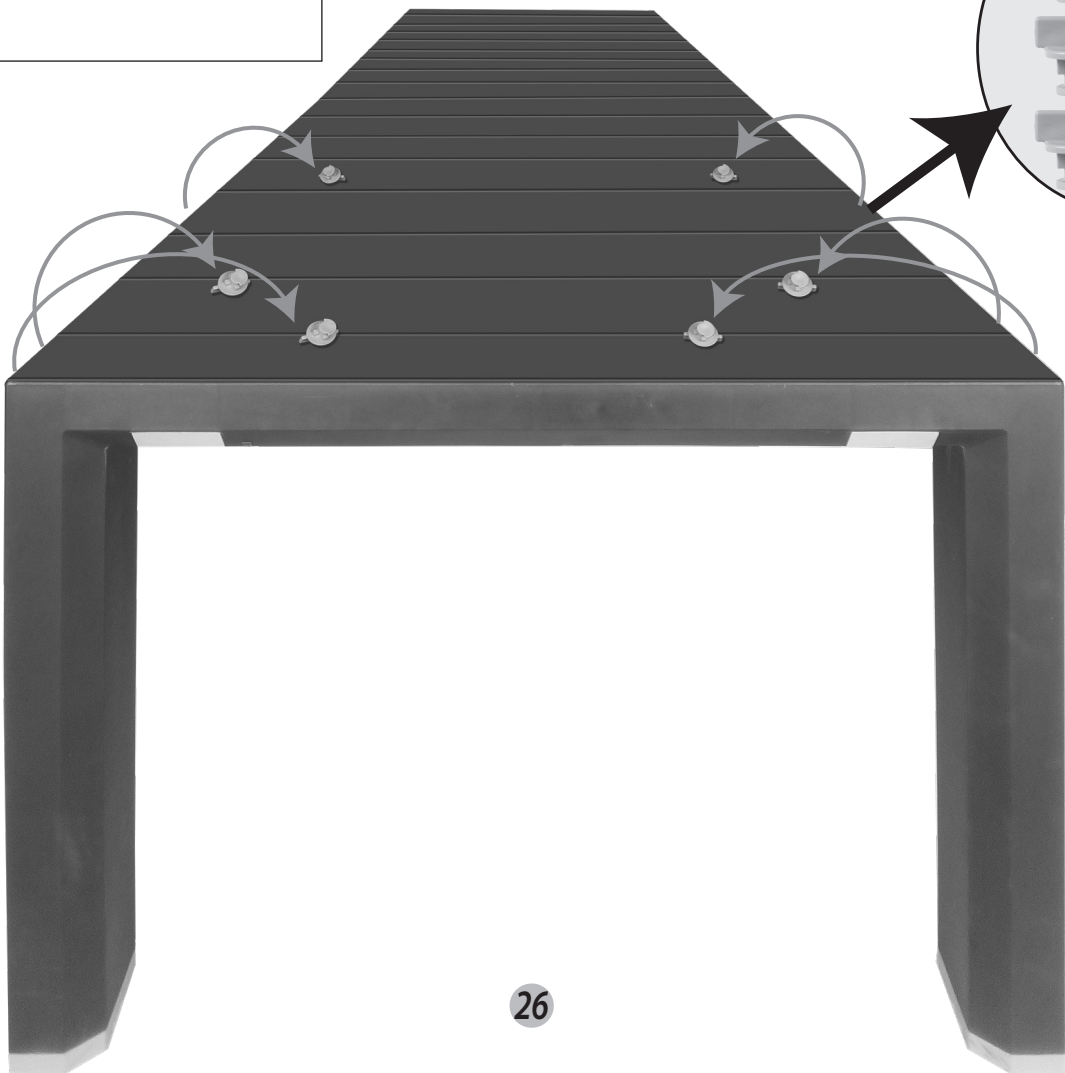
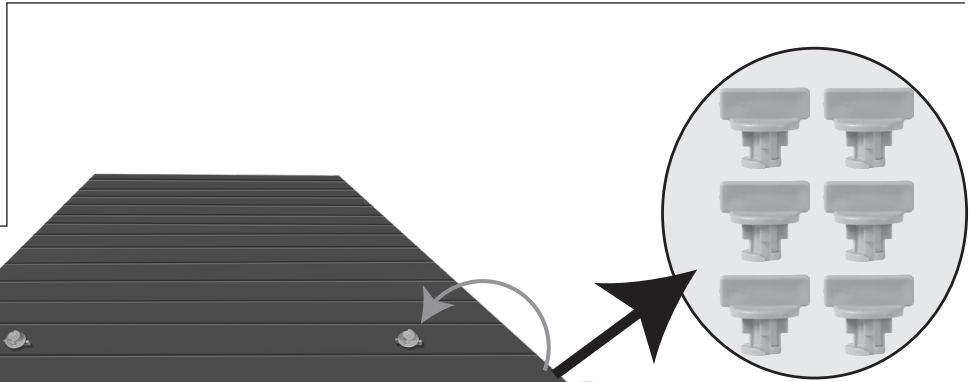

26

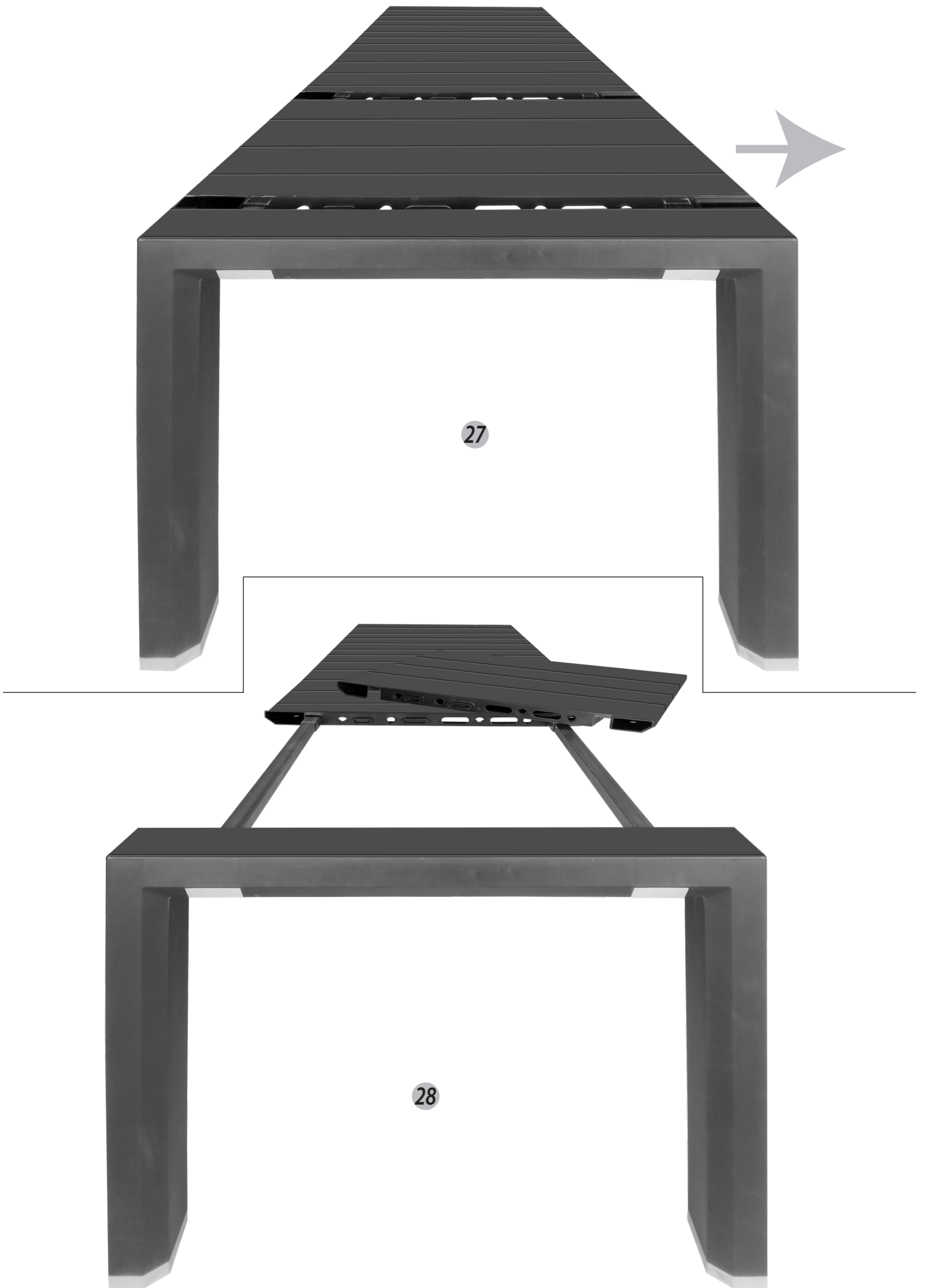

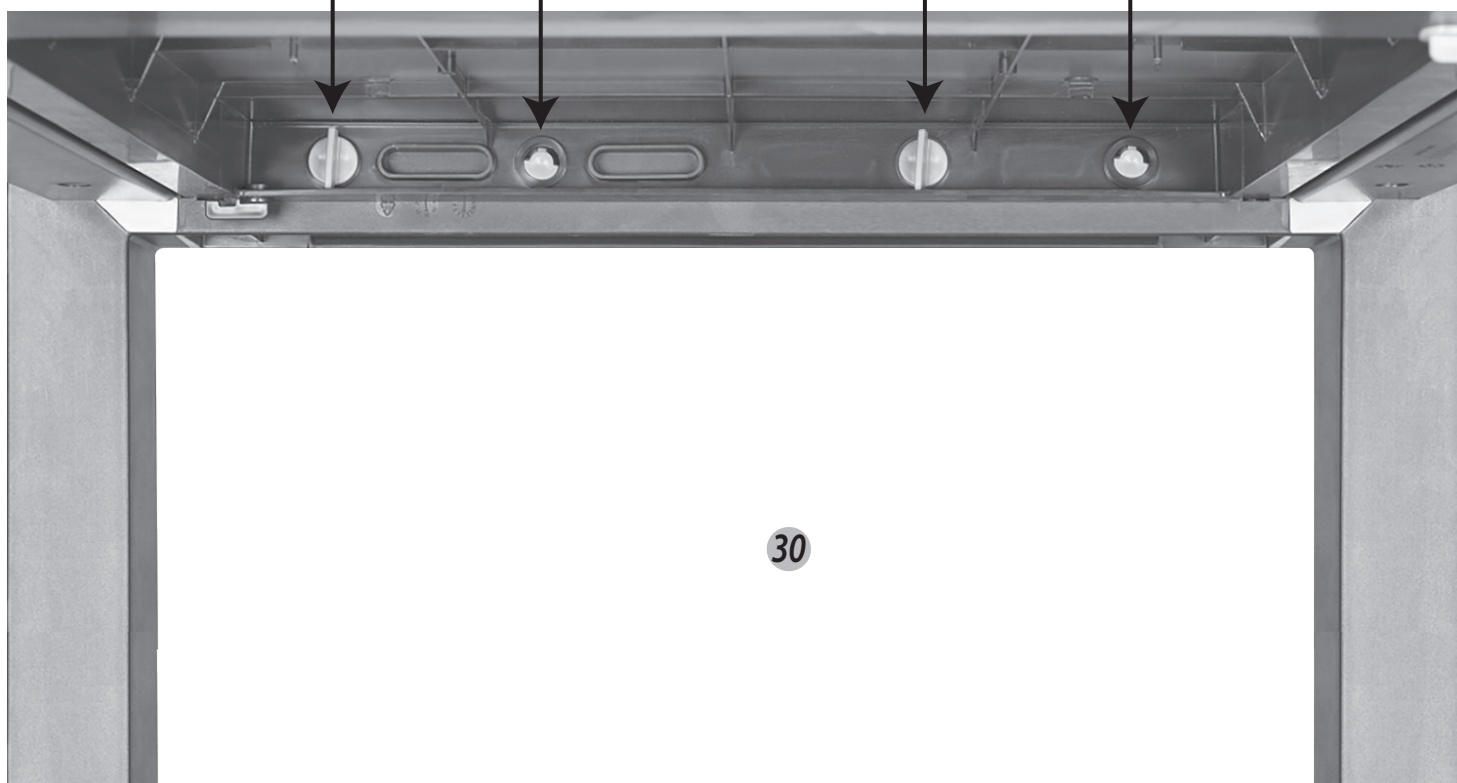



- I** **ATTENZIONE!** Al primo montaggio del tavolo, per un corretto scorrimento delle barre in acciaio lubrificarle nei punti indicati.  
*Ripetere periodicamente la procedura.*
- GB** **WARNING!** When assembling the table for the first time, for correct sliding of the steel bars, lubricate them at the points indicated.  
*Periodically repeat the procedure.*
- F** **ATTENTION!** Lors du premier assemblage de la table, pour un coulisement correct des barres d'acier, les lubrifier aux points indiqués.  
*Répétez périodiquement la procédure.*
- D** **WARNUNG!** Bei der ersten Montage des Tisches schmieren Sie die Stahlstangen an den angegebenen Stellen, damit sie richtig gleiten.  
*Wiederholen Sie den Vorgang regelmäßig.*
- E** **ADVERTENCIA!** Al montar la mesa por primera vez, para el correcto deslizamiento de las barras de acero, lubrique en los puntos indicados.  
*Repita periódicamente el procedimiento.*
- P** **AVISO!** Ao montar a mesa pela primeira vez, para correto deslizamento das barras de aço, lubrifiquê-as nos pontos indicados.  
*Repita o procedimento periodicamente.*

